

UM800xSL & UM801xSL 9'oc/11'oc **Starlight Collar Tilt**

Assembly and Operation Guide



Thank you for your purchase of Treasure Garden's Starlight Collar Tilt Umbrella.

Please remove all contents from the package, inspect and review checklist.

STARLIGHT COLLAR TILT CHECKLIST

A - Finial

B - Canopy/Mainframe

C - Bottom Pole

D - Power Cord/Transformer

Note: Use only the Power Cord/Transformer supplied.

A -



B -



C -



D -

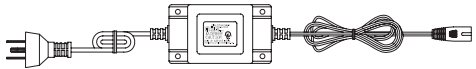

STEP 1 Set Up

Carefully remove umbrella from box. Attach finial to top of canopy/mainframe.

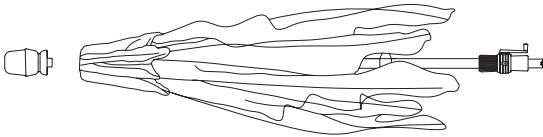

Connect bottom pole plug to canopy/mainframe plug. Twist plug clockwise  together to secure connection.

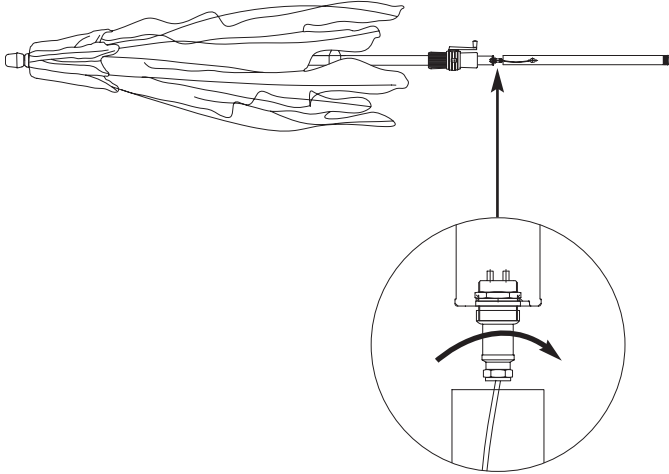

Insert bottom pole into canopy/mainframe pole. Line up button with hole and snap into place.

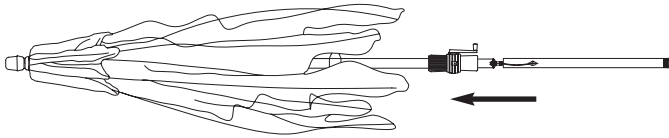

Turn umbrella in upright position. Insert bottom pole into free standing base or through table top. Insert power supply/transformer into umbrella pole. Connect other end of power supply/transformer into wall outlet.

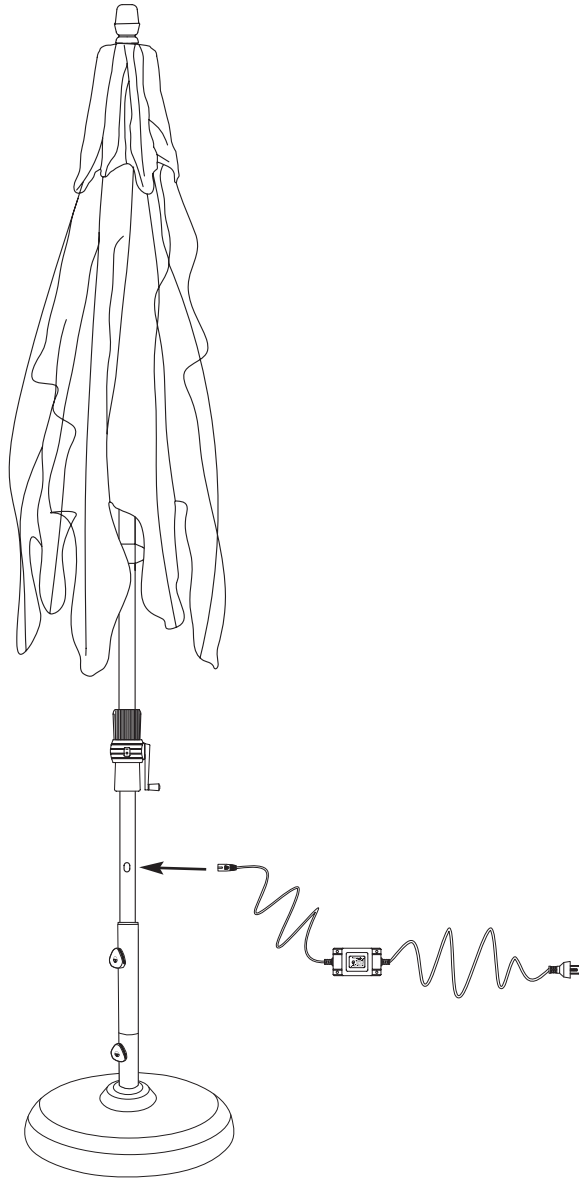

Note: The transformer output power is 12V. It is normal for transformer to get warm after long period of use. Avoid sun on power supply/transformer to increase lifetime use. Be sure not to drop transformer. *Note: Use only the Power Cord/Transformer supplied.*

STEP 2 Operating Umbrella

Crank handle clockwise to open umbrella to its fully open position. To turn umbrella on or off, press on/off switch located on collar housing.

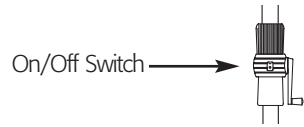
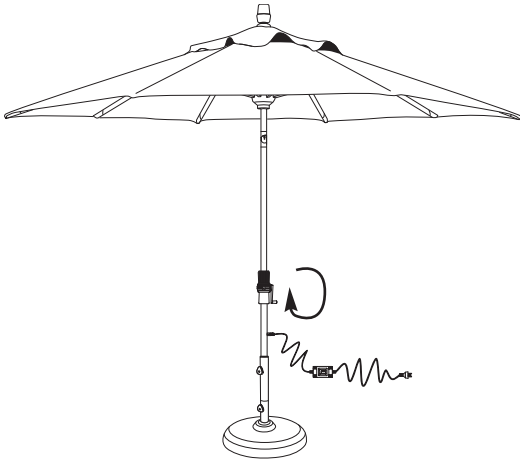

To tilt, simply twist the collar in clockwise direction.

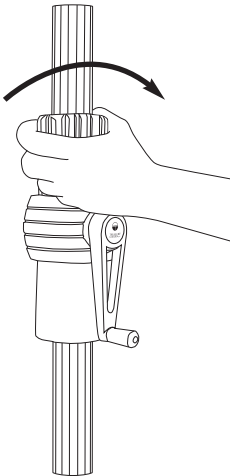

STEP 3 Closing Umbrella

Twist collar in counter-clockwise direction to bring umbrella back to its original upright position. Turn umbrella off by clicking switch to off position.

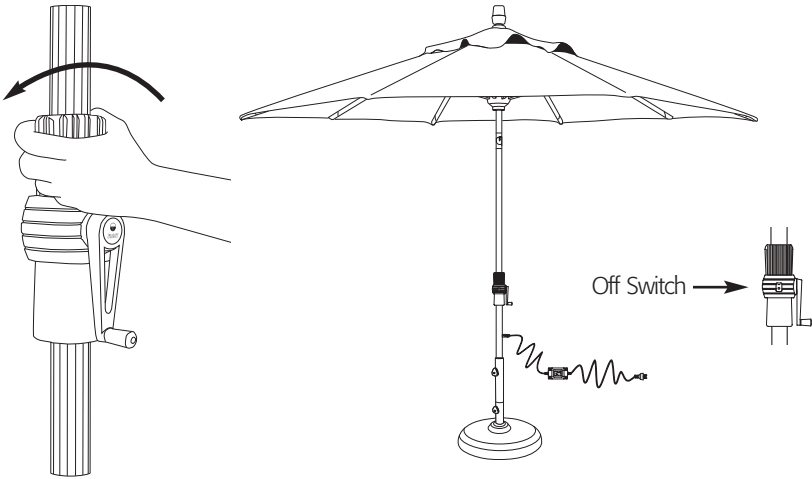

To close, turn crank in counter-clockwise direction to close umbrella.

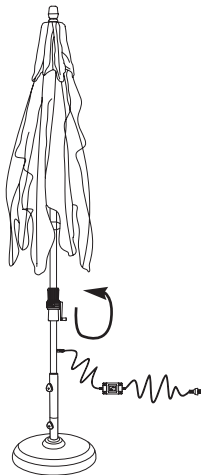

To store umbrella away, unplug power supply/transformer from wall and umbrella pole. Repeat Step 1 process in reverse to store.

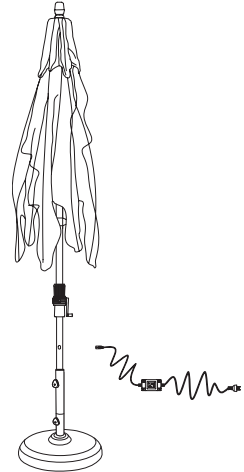

Note: During disassembly, it is important to loosen knob of plug *inside* umbrella poles **first**, then remove bottom pole from mainframe/canopy. If not, the wire will be split and result in damage to lighting.

WARRANTY:

Treasure Garden warrants this product (in residential use) to be free from defects in original materials and workmanship for a period of 2 years from the date of purchase. If a defect in the original material or workmanship appears during the warranty period; Treasure Garden will (at its option) repair or replace the product without charge. Limited warranty against fabric fading, depending on fabric.

Simply contact your original authorized Treasure Garden dealer with a description of the defect. The dealer will verify the defect and work closely with Treasure Garden to obtain the necessary service. In many cases, simple problems can be solved with a replacement part that can be shipped directly to the dealer for professional installation/repair.

In the event that warranted factory service is required, Treasure Garden will assume the responsibility of the return freight charges on warranted product for the 2 years only.

Returned product that (upon receipt and inspection) is deemed to be "not covered" under our warranty, will be shipped/billed at your expense.

This warranty gives you specific legal rights, and you may have other rights which vary from state to state.

NOTE: Failure caused by unreasonable or abusive use, or failure caused by neglect of reasonable and necessary care are not covered by this warranty.

Additionally, acts of nature (including but not limited to wind, hurricanes, tornadoes, and storms) are not covered by this warranty.

S A F E T Y P R E C A U T I O N S :

- Close and store the umbrella in windy conditions or when a storm approaches. Never allow the umbrella to flap in the wind; this could damage the canopy.
- Do not leave open umbrella unattended. If damage occurs, this is not covered by the warranty.
- When adjusting the umbrella, make sure that no person(s) or item(s) are close to the umbrella. This is important to prevent injury or material damage.

C A R E A N D M A I N T E N A N C E :

- When not in use, close and cover umbrella with a protective cover (not included).
- Allow a wet canopy to dry while in open position.
- If necessary, clean the fabric with lukewarm water, mild detergent, and a sponge.
- Wipe sliding marks on the aluminum poles with a damp cloth.

Storage:

- Store in a dry, protective place.
- Any visible defects must be repaired by a professional.

After the Winter:

- Areas subject to turning and sliding can be treated with a non-staining lubricant spray (silicone-based).
- Check the condition and function of the umbrella. Any defects must be repaired by a professional.



www.treasuregarden.com

©2012 Treasure Garden, Inc. - All Rights Reserved.

Version 5/12